

Version 1.2

Reference Manual

C DA 5011

SDI to Analog Video Conv. & Line Synchronizer

Series 5000
CardModule

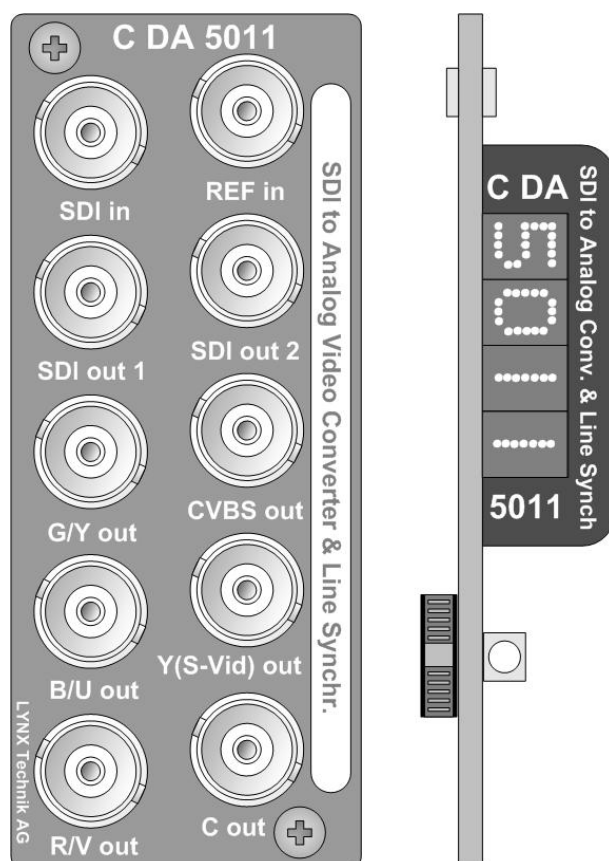

© LYNX Technik AG
Brunnenweg 3
D-64331 Weiterstadt
Germany
www.lynx-technik.com

Information in this document is subject to change without notice. No part of this document may be reproduced or transmitted in any form or by any means, electronic or mechanical for any purpose, without express written permission of LYNX Technik AG.

LYNX Technik AG may have patents, patent applications, trademarks, copyrights or other intellectual property rights covering the subject matter in this document. Except as expressly written by LYNX Technik AG, the furnishing of this document does not give you any license to patents, trademarks, copyrights or other intellectual property of LYNX Technik AG or any of its affiliates.

© LYNX Technik AG 2003 all rights reserved

Warranty

LYNX Technik AG warrants that the product will be free from defects in materials and workmanship for a period of two (2) year from the date of shipment. If this product proves defective during the warranty period, LYNX Technik AG at its option will either repair the defective product without charge for parts and labor, or will provide a replacement in exchange for the defective product.

In order to obtain service under this warranty, customer must notify LYNX Technik of the defect before expiration of the warranty period and make suitable arrangements for the performance of service. Customer shall be responsible for packaging and shipping the defective product to the service center designated by LYNX Technik, with shipping charges prepaid. LYNX Technik shall pay for the return of the product to the customer if the shipment is within the country which the LYNX Technik service center is located. Customer shall be responsible for payment of all shipping charges, duties, taxes and any other charges for products returned to any other locations.

This warranty shall not apply to any defect, failure, or damage caused by improper use or improper or inadequate maintenance and care. LYNX Technik shall not be obligated to furnish service under this warranty a) to repair damage resulting from attempts by personnel other than LYNX Technik representatives to install, repair or service the product; b) to repair damage resulting from improper use or connection to incompatible equipment; c) to repair any damage or malfunction caused by the use of non LYNX Technik supplies; or d) to service a product which has been modified or integrated with other products when the effect of such modification or integration increases the time or difficulty servicing the product.

THIS WARRANTY IS GIVEN BY LYNX TECHNIK WITH RESPECT TO THIS PRODUCT IN LIEU OF ANY OTHER WARRANTIES, EXPRESS OR IMPLIED. LYNX TECHNIK AND ITS VENDORS DISCLAIM ANY IMPLIED WARRANTIES OF MERCHANTABILITY OR FITNESS FOR A PARTICULAR PURPOSE. LYNX TECHNIK`S RESPONSIBILITY TO REPAIR AND REPLACE DEFECTIVE PRODUCTS IS THE SOLE AND EXCLUSIVE REMEDY PROVIDED TO THE CUSTOMER FOR BREACH OF THIS WARRANTY. LYNX TECHNIK AND ITS VENDORS WILL NOT BE LIABLE FOR ANY INDIRECT, SPECIAL, INCIDENTAL, OR CONSEQUENTIAL DAMAGES IRRESPECTIVE OF WHETHER LYNX TECHNIK OR THE VENDOR HAS ADVANCE NOTICE OF THE POSSIBILITY OF SUCH DAMAGES.

Regulatory information

Europe

Declaration of Conformity

We	LYNX Technik AG Brunneweg 3 D-64331 Weiterstadt Germany
<i>Declare under our sole responsibility that the product</i>	
TYPE: C DA 5011	
<i>To which this declaration relates is in conformity with the following standards (environments E1-E3):</i>	
EN 55103-1 /1996	
EN 55103-2 /1996	
EN 60950 /2001	
<i>Following the provisions of 89/336/EEC and 73/23/EEC directives.</i>	
	Winfried Deckelmann
Weiterstadt, January 2004	
<i>Place and date of issue</i>	<i>Legal Signature</i>

USA

FCC 47 Part 15

This device complies with part 15 of the FCC Rules. Operation is subject to the following two conditions: (1) This device may not cause harmful interference, and (2) this device must accept any interference received, including interference that may cause undesired operation.

Note: This equipment has been tested and found to comply with the limits for a Class A digital device, pursuant to the part 15 of the FCC Rules. These limits are designed to provide reasonable protection against harmful interference when the equipment is operated in a commercial environment. This equipment generates, uses, and can radiate radio frequency energy and, if not installed and used in accordance with the instruction manual, may cause harmful interference to radio communications. Operation of this equipment in a residential area is likely to cause harmful interference in which case the user will be required to correct the interference at his own expense

Contents

Warranty	3
Regulatory information.....	4
Europe.....	4
Declaration of Conformity	4
USA	4
FCC 47 Part 15.....	4
Contents	5
Getting Started.....	7
Packaging.....	7
Product Description	7
Functional Diagram	9
Module Layout.....	9
Connections	11
Video Connections.....	11
Installation	12
Settings and Control	13
Multi Function Switch	14
Using the Local Display Menus.....	15
Navigation.....	15
Local Adjustments Available.....	15
Menu Structure	16
Factory Preset Condition.....	19
Auto Store	19
Alarm/LED Status Indicators.....	20
Status Indicators.....	20
Alarm Indicator	20
Locate Function	21
Specifications (C DA 5011)	22
Available Options	23
Parts List.....	23
Service	24
Contact Information	25

This page is intentionally left blank

Getting Started

Packaging

The shipping carton and packaging materials provide protection for the module during transit. Please retain the shipping cartons in case subsequent shipping of the product becomes necessary.

Product Description

The C DA 5011 is a high quality 10 bit video D/A converter and line synchronizer designed primarily for broadcast and professional applications.

The Module accepts 1 SDI input signal and provides a RGB or YUV component analog output. It also provides 3 x CVBS, or 1x CVBS and one S-Video (Y/C) output (in parallel to the component analog output selected). The component outputs can also be configured to provide 3 x Black Burst reference outputs if required. The outputs are line synchronized to the reference input. The CVBS outputs are phase locked to the reference input. Two re-clocked SDI loop through signals are provided for further use downstream.

The C DA 5011 has a variety of features, which includes:

- Component RGB or YUV component video outputs plus
- 3x CVBS or CVBS and a S video output (Y/C)
- 3 x Black Burst output selectable (on component outputs)
- Line Synchronizer mode (max. 3 lines delay)
- CVBS color phase locked to reference
- PAL or NTSC operation, auto detect
- Internal color bars
- Internal 4x over sampling (54MHz)
- 2 x reclocked SDI loop through outputs

- Multi function switch and Matrix display for control and status monitoring.
- Microprocessor controlled.
- Remote control interface.

The module has a built in micro-controller with local controls, status and alarm indicators as well as internal flash ram for storing setups. Any operational parameters configured and stored into the module are recalled when powered up. Remote control and remote status monitoring is possible when using the optional rack controller

CardModules are installed in the series 5000 card frame that can accommodate up to 10 CardModules. All modules are hot swappable and options include full redundant power and a range of controller options.

Functional Diagram

Figure 1 below is the basic functional diagram for the C DA 5011 CardModule.

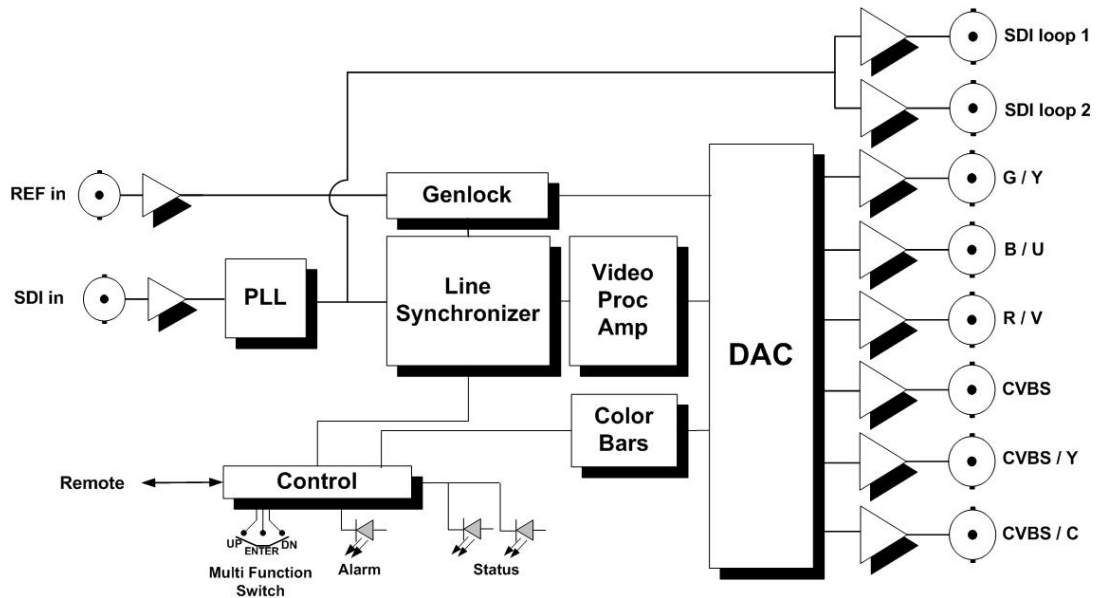
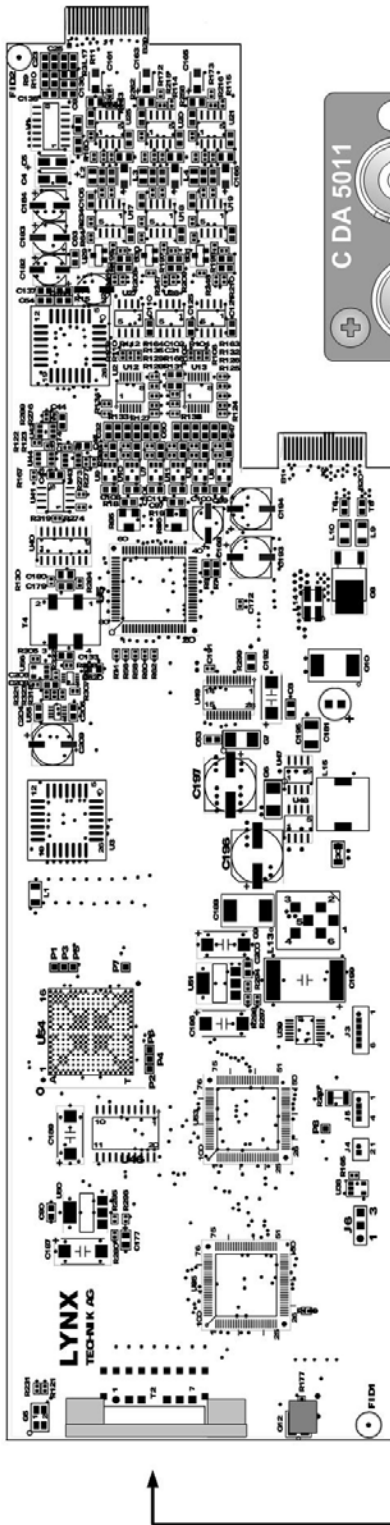

Figure 1- C DA 5011 Functional Diagram

Module Layout

Figure 2 shows the physical layout of the C DA 5011 CardModule and also the connection panel which is fitted to the rear of the rack.

PCB Layout



Rear Connection Panel

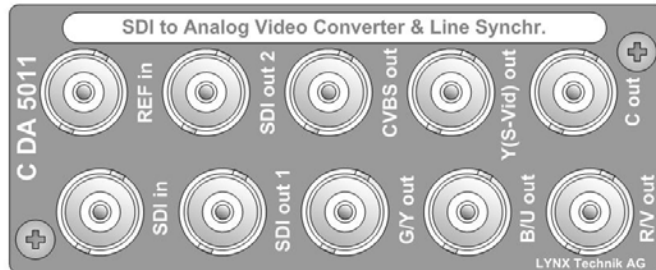

PCB Front View

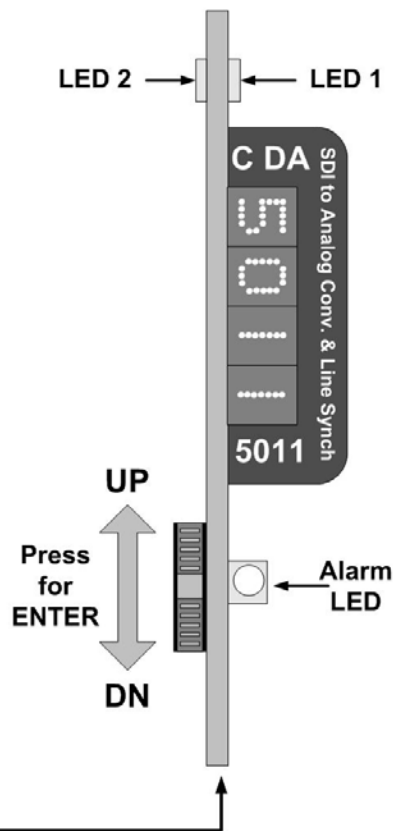

Figure 2 – Module Layout



Caution

Use static precautions when handling the PCB. Static discharge could result in serious damage to the module.

Connections

Video Connections

The C DA 5011 CardModule is configured with standard 75 Ohm BNC connectors. Connection is self-explanatory. We recommend the use of high quality video cables for digital video connections to reduce the risk of interference or errors due to excessive cable attenuation. Some guidelines for max cable length are shown below.

250m (820 feet) Belden 8281 (270Mbits/s)

Note. Due to the compact design of the connection plate it will be necessary to use a connection tool to secure the BNC video connectors.

Installation



Caution

The CardModule is shipped in a protective anti-static bag. Please take suitable precautions to avoid static discharge onto any part of the PCB or components when handling module or serious damage could result.

Each Card Module is supplied with a rear connection panel and two mounting screws. Please follow the following procedure for installation of the card module into the Series 5000 Card Frame.

- a) Select a slot in the card frame where the CardModule will be located
- b) Remove the blank connection panel from the rear of the rack (if fitted)
- c) Install the rear connection panel using the screws supplied. Do not tighten the screws fully
- d) Slide the card module into the card frame and carefully check the CardModule easily connects to the rear connection plate. The card should fit easily and should not require excessive force to insert, if you feel any resistance, there could be something wrong with the rear connection panel location. Do not try and force the connection. Remove the rear connection panel and check alignment with the CardModule.
- e) Insert and remove the CardModule a few times to ensure correct alignment and then tighten the two screws to secure the rear connection plate

Settings and Control

The C DA 5011 has an integrated micro-controller, which enables the module to be configured and controlled locally using the multifunction switch and 4 character dot matrix display, or from remote when using one of the optional controllers and control software.

Once set, all settings are automatically saved in non-volatile internal memory. (Flash ram) The module will always recall the settings used prior to power down.

PCB Front View

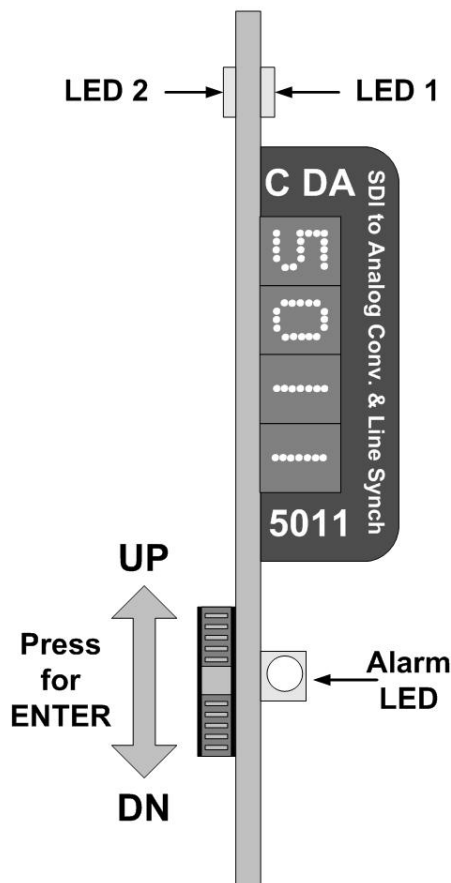
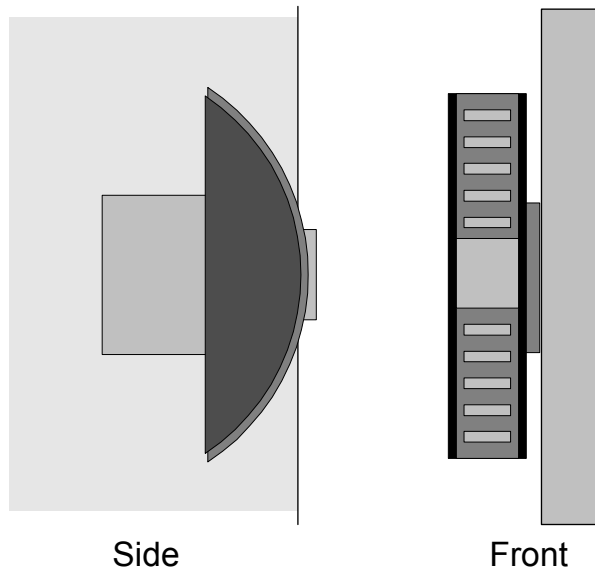

Figure 3 – Switch and Display Location

Multi Function Switch

The CardModule is equipped with a multi-function switch located on the front bottom edge of the card (refer to figure 3)

Multi-function Switch



Switch Operations

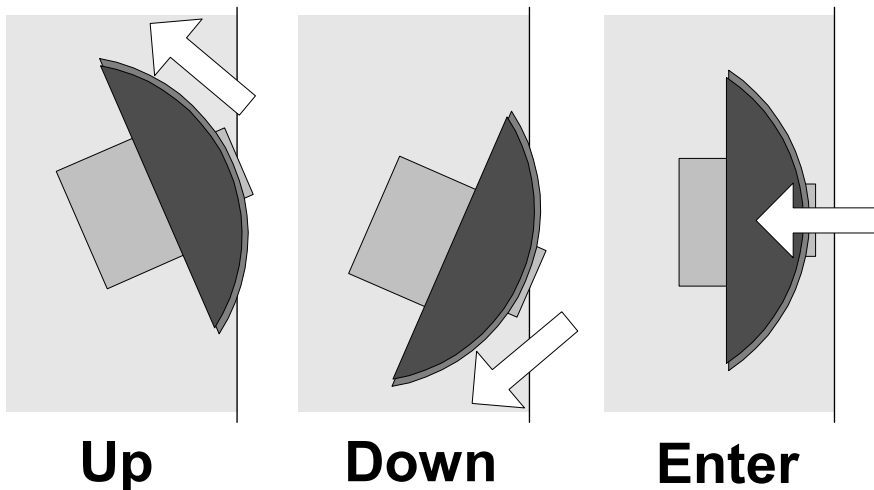

Figure 4 – Switch Operation

Using the Local Display Menus

Making local adjustments to the module is done using the multifunction switch and the integrated 4-character dot matrix display (figure 3). The menu system is layered, and navigation through the system is done using the **UP** and **DOWN** functions of the switch. **ENTER** is used to move between menu levels and also enter a selection.

Navigation

Switch Function	Operation
UP	Move UP within a level
DOWN	Move down within a level
ENTER	Change levels / Make selection

Local Adjustments Available

All of the critical adjustments to the module are accessible using the local display and multi-function switch, these include:

- Output select (CVBS, Component, Y/C)
- Test signal select
- Genlock mode
- Delay settino incl. phase of 8V sequence

Menu Structure

The Menu structure is defined in the next table, and should be used when navigating through the system.

Notes / Tips.

ENTER moves between Levels

UP/DOWN moves between items within the level

When you enter a new setting the system will jump back one level in the menu system.

The “back” selection in the menu structure will take you back one level when selected.

When an item is selected which has several setting possibilities the first value displayed will be the value currently stored in the system. The order of the available settings for any menu item in the table supplied does not represent the order the settings will actually be displayed.

If left unattended, the menu will default to the root display after a preset timeout.

ROOT	LEVEL 1	LEVEL 2	LEVEL 3	LEVEL 4	COMMENTS
5011	OUT	OUT1	YUV RGB BLK back		"Normal" Root display on module = Module type
		OUT2	YC CVB back		Output signal select for output 1: - YUV: Component (Y Pr Pb) - RGB - BLK: 3 x Black Burst
		NoIN	BLK BAR back		Output signal select for output 2: - YC: 1 x CVBS and YC - CVB: 3 x CVBS
		back			Output signal select if no input: - BLK: Black - BAR: Color Bars
	REF	INT EXT OFF back			Reference signal select: - INT: Rack Reference - EXT: Board Reference - OFF: SDI input signal is reference

<p>Set Delay: -LINE: 0..3 -PIX: PAL: 0..1728 NTSC: 0..1716 -SCPH: Set phase of 8V sequence (0..7)</p>		<p>0000 0000</p>	<p>LINE PIX SCPH back</p>	<p>DLY VBI</p>	
<p>Vertical Blanking Interval (VBI): -TRA: Transparent -BLNK: VBI blanked</p>			<p>TRA BLNK back</p>	<p>VBI</p>	
<p>Test Signal Select: -OFF: Normal Operation -BAR: Color Bars on outputs</p>		<p>OFF BAR back</p>	<p>SLCT STD back</p>	<p>TEST</p>	
<p>Test Signal Standard: -AUTO: Standard is last recognized input or reference</p>		<p>AUTO 525 525 back</p>	<p>STD back</p>	<p>TEST</p>	
<p>Factory Reset: - Sets all parameters to factory settings</p>			<p>NO YES</p>	<p>RESET back</p>	

Factory Preset Condition

The C DA 5011 is delivered preset for the following mode of operation:

- YUV Output
- CVBS, YC Output
- Black if no input
- Rack Reference (INT) selected
- Delays = 0
- VBI transparent
- Standard Select = AUTO
- Test signal OFF
- Test signal format PAL

If this is the mode of operation required, then no adjustments are necessary.

Auto Store

If no parameters are changed for 10 seconds then the current settings will be written into flash memory automatically, this can be seen by the alarm LED flashing yellow four times.

Alarm/LED Status Indicators

The C DA 5011 module has three LED indicators, which serve as alarm and status indication for the module. (Figure 2 or 3). Function is described below.

Status Indicators

2 status LEDs are provided on the module edge

LED 1	Same as Alarm indicator
Green	Valid Reference detected
Yellow	Valid Reference detected, but not selected
Red	No Reference detected

LED 2	Indication
Green	Input signal present
Yellow	Test pattern selected (color bars)
Red	Input signal missing

Alarm Indicator

There is also a general alarm LED on the lower edge of the module, which can be seen when the rack front cover is fitted.

LED Color	Indication
Green	Input signal present and reference detected
Yellow	Test pattern selected (color bars) or Reference selected, but not detected
Red	Input signal missing

LED **OFF** indicates power is lost, or there is a power supply fault.

Locate Function

For larger systems which may have multiple MiniModules of the same type in a single rack, or multiple rack systems on a large central control system we have added a useful utility which will help to visually locate a suspect module quickly (When used in conjunction with the optional control system and software)

Once the specific module has been selected on the control system there is a locate button on the top of the GUI:

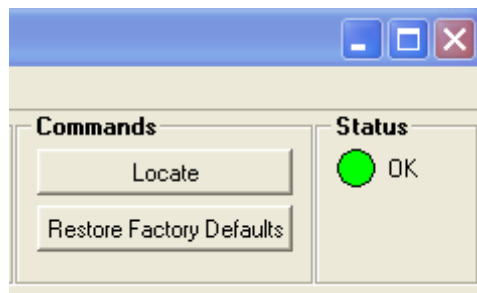

Locate Function in Control System

When Locate is selected the status indicator on the GUI and the module LED`s will flash yellow in the following continuous sequence.

3 short flashes.... Pause.... 3 short flashes ...

This uses the alarm LED located on the front of the module and in some cases any channel or status LED`s that may be used in the module.

Use of the locate function will not interfere with the normal operation of the module.

For more details on this feature please check the documentation supplied with the controller software.

Specifications (C DA 5011)

Inputs

Signal	Serial 4:2:2 SMPTE 259M-C (270 Mbit/s) Standards NTSC-(M/N), PAL (B/D/G/H/I/N/60) Auto detection
Return Loss	>15dB (270MHz)
Connection	BNC
Impedance	75 Ohms

Outputs

Signal (component)	YUV or RGB component analog or 3 x Black Burst reference (selectable)
Signal (composite)	3 x CVBS or 1x CVBS and S-Video (Y/C) (selectable)
Return Loss	>35dB (5,75MHz)
Connections	BNC
Impedance	75 Ohms

Operating Modes

Conversion	D/A conversion for SDI-Signals
Line Synch	horizontal output timing adjusted to reference, delay is between 5us and 3 lines
TV Standard	NTSC or PAL (Auto detect)
Test	Internal Color Bars

Performance

Quantization	10 Bits
Sampling	54 MHz (4x Over sampling)
Filters	Selectable Chroma and Luma filters (remote only)
S/N Ratio	< -60 dB (unweighted to 5,75 MHz)

Electrical Specifications

Operating Voltage	+ 5VDC
Power Consumption	6 W
Safety	IEC 60950/ EN 60950/VDE 0805

Mechanical

Size	283mm x 78mm
Weight	Card module 120g, connection panel 50g

Ambient

Temperature	5°C to 40°C Maintaining specifications -20°C to +70°C Storage
Humidity	Max 90% non condensing

Supplied Accessories

Documentation	C DA 5011 Reference Manual
---------------	----------------------------

Available Options

Below is a list of related products for the C DA 5011 CardModule. Please refer to product brochures or our web site for more detailed information.

Model	Description
R FR 5010	Series 5000 Rack Frame (empty) with single power supply
R PS 5010	Redundant power supply for the R FR 5010 Card Frame
R CT 5020	Rack controller for the R FR 5010 Card Frame
R CT 5010	Rack Bus Extension for the R FR 5010 Card Frame. In combination with R CT 5020

Parts List

Due to the very dense design and miniature surface mount technology the module is not field serviceable. The information for a replacement assembly is below.

C DA 5011 CardModule (complete)

Description SDI to Ana. Vid. Conv.
 Model Number C DA 5011
 Part Number 6.155.008.320

Sub Assemblies:

C DA 5011 Processing Board only (BS 5010_C)

Part Number 6.155.006.320

Rear Connection Panel for C DA 5011 (MA3001_B)

Part Number 6.155.001.250

Rear Connection Foil for C DA 5011

Part Number 6.155.001.635

Service

If you are experiencing problems, or have questions concerning your C DA 5011 CardModule please contact your local distributor for assistance.

We offer a fixed cost service exchange program for defective Series 5000 CardModules out of Warranty. Please contact your distributor or check our web site for details on this program.

More detailed information and product updates may be available on our web site:

www.lynx-technik.com

You will also find links to contact us directly for assistance.

Contact Information

Please contact your local distributor; this is your local and fastest method for obtaining support and sales information.

LYNX Technik can be contacted directly using the information below.

Address LYNX Technik AG
Brunnenweg 3
D-64331 Weiterstadt
Germany.

Website www.lynx-technik.com

E-Mail info@lynx-technik.com

LYNX Technik manufactures a complete range of high quality modular products for broadcast and Professional markets, please contact your local representative or visit our web site for more product information.



This page is intentionally left blank

