



Reference Manual

D VA 5720

Dual Analog Video Distribution Amplifier

Series 5000
CardModule

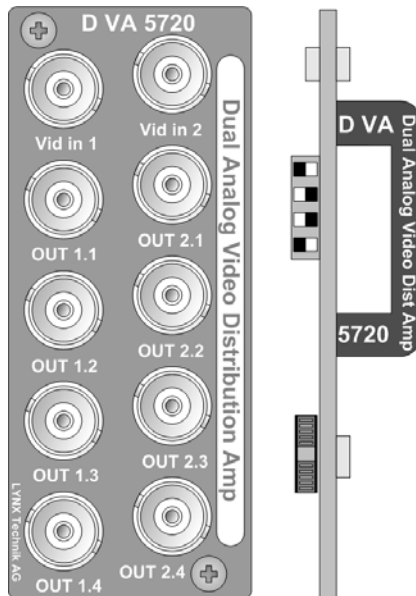

© LYNX Technik AG
Brunnenweg 3
D-64331 Weiterstadt
Germany
[Hwww.lynx-technik.com](http://www.lynx-technik.com)

Information in this document is subject to change without notice. No part of this document may be reproduced or transmitted in any form or by any means, electronic or mechanical for any purpose, without express written permission of LYNX Technik AG.

LYNX Technik AG may have patents, patent applications, trademarks, copyrights or other intellectual property rights covering the subject matter in this document. Except as expressly written by LYNX Technik AG, the furnishing of this document does not give you any license to patents, trademarks, copyrights or other intellectual property of LYNX Technik AG or any of its affiliates.

© LYNX Technik AG 2008 all rights reserved

Warranty

LYNX Technik AG warrants that the product will be free from defects in materials and workmanship for a period of two (2) years from the date of shipment. If this product proves defective during the warranty period, LYNX Technik AG at its option will either repair the defective product without charge for parts and labor, or will provide a replacement in exchange for the defective product.

In order to obtain service under this warranty, customer must notify LYNX Technik of the defect before expiration of the warranty period and make suitable arrangements for the performance of service. Customer shall be responsible for packaging and shipping the defective product to the service center designated by LYNX Technik, with shipping charges prepaid. LYNX Technik shall pay for the return of the product to the customer if the shipment is within the country which the LYNX Technik service center is located. Customer shall be responsible for payment of all shipping charges, duties, taxes and any other charges for products returned to any other locations.

This warranty shall not apply to any defect, failure, or damage caused by improper use or improper or inadequate maintenance and care. LYNX Technik shall not be obligated to furnish service under this warranty a) to repair damage resulting from attempts by personnel other than LYNX Technik representatives to install, repair or service the product; b) to repair damage resulting from improper use or connection to incompatible equipment; c) to repair any damage or malfunction caused by the use of non LYNX Technik supplies; or d) to service a product which has been modified or integrated with other products when the effect of such modification or integration increases the time or difficulty servicing the product.

THIS WARRANTY IS GIVEN BY LYNX TECHNIK WITH RESPECT TO THIS PRODUCT IN LIEU OF ANY OTHER WARRANTIES, EXPRESS OR IMPLIED. LYNX TECHNIK AND ITS VENDORS DISCLAIM ANY IMPLIED WARRANTIES OF MERCHANTABILITY OR FITNESS FOR A PARTICULAR PURPOSE. LYNX TECHNIK'S RESPONSIBILITY TO REPAIR AND REPLACE DEFECTIVE PRODUCTS IS THE SOLE AND EXCLUSIVE REMEDY PROVIDED TO THE CUSTOMER FOR BREACH OF THIS WARRANTY. LYNX TECHNIK AND ITS VENDORS WILL NOT BE LIABLE FOR ANY INDIRECT, SPECIAL, INCIDENTAL, OR CONSEQUENTIAL DAMAGES IRRESPECTIVE OF WHETHER LYNX TECHNIK OR THE VENDOR HAS ADVANCE NOTICE OF THE POSSIBILITY OF SUCH DAMAGES.

Regulatory information

Europe

Declaration of Conformity

We	LYNX Technik AG Brunnenweg 3 D-64331 Weiterstadt Germany
<i>Declare under our sole responsibility that the product</i>	
TYPE: D VA 5720	
<i>To which this declaration relates is in conformity with the following standards (environments E1-E3):</i>	
EN 55103-1 /1996	
EN 55103-2 /1996	
EN 60950 /2001	
<i>Following the provisions of 89/336/EEC and 73/23/EEC directives.</i>	
Winfried Deckelmann	
Weiterstadt, November 2008	
<i>Place and date of issue</i>	<i>Legal Signature</i>

USA

FCC 47 Part 15

This device complies with part 15 of the FCC Rules. Operation is subject to the following two conditions: (1) This device may not cause harmful interference, and (2) this device must accept any interference received, including interference that may cause undesired operation.

Note: This equipment has been tested and found to comply with the limits for a Class A digital device, pursuant to the part 15 of the FCC Rules. These limits are designed to provide reasonable protection against harmful interference when the equipment is operated in a commercial environment. This equipment generates, uses, and can radiate radio frequency energy and, if not installed and used in accordance with the instruction manual, may cause harmful interference to radio communications. Operation of this equipment in a residential area is likely to cause harmful interference in which case the user will be required to correct the interference at his own expense

Contents

Warranty	3
Regulatory information	4
Europe.....	4
Declaration of Conformity	4
USA	4
FCC 47 Part 15.....	4
Contents	5
Getting Started	7
Packaging	7
Product Description	7
Functional Diagram	8
Module Layout	8
Connections	10
Video Connections.....	10
Installation	11
Settings and Control	12
Switch Settings	12
Switch Function Detail	13
Factory Preset Condition	13
Link Settings	14
Input coupling.....	14
Input Clamp	14
Adjustment Procedures	16
Set Dual 1:4 or 1:8 mode	17
Set Video Gain.....	18
Set Equalization.....	19
Set Unity Gain.....	20
Set Unity Equalization	21
Auto Store	21
Alarm/LED Status Indicators	22
Channel Condition Indicators	22
Front Panel Alarm Indicator	22
Locate Function.....	23
Specifications (D VA 5720)	24
Available Options	25
Parts List	25
Service	26
Contact Information	27

This page is intentionally left blank

Getting Started

Packaging

The shipping carton and packaging materials provide protection for the module during transit. Please retain the shipping cartons in case subsequent shipping of the product becomes necessary.

Product Description

The D VA 5720 is a high quality analog video distribution amplifier designed primarily for broadcast and professional applications.

Flexible configurations allow the module to be used in dual 1 to 4 applications or single channel 1 to 8 applications. Independent gain and equalization adjustments are provided for each channel. SDTV and HDTV analog signals are supported including detection of the HDTV Tri Level Sync.

The module is microprocessor controlled and all settings are stored in internal flash ram. Presence detection is provided via status LED's and a front side alarm LED is also provided. Optional remote control / status reporting and SNMP error reporting is supported when using the LYNX central control system. The LYNX control system is set up to do this most of the time

The D VA 5120 is part of the 5000 series of CardModules, which offer high quality, modularity and flexibility in a small form factor ideal for applications where space is at a premium.

CardModules are installed in the series 5000 card frame that can accommodate up to 10 CardModules. All modules are hot swappable and Options include full redundant power and a range of controller options.

Functional Diagram

Figure 1 below is the basic functional diagram for the D VA 5720 CardModule.

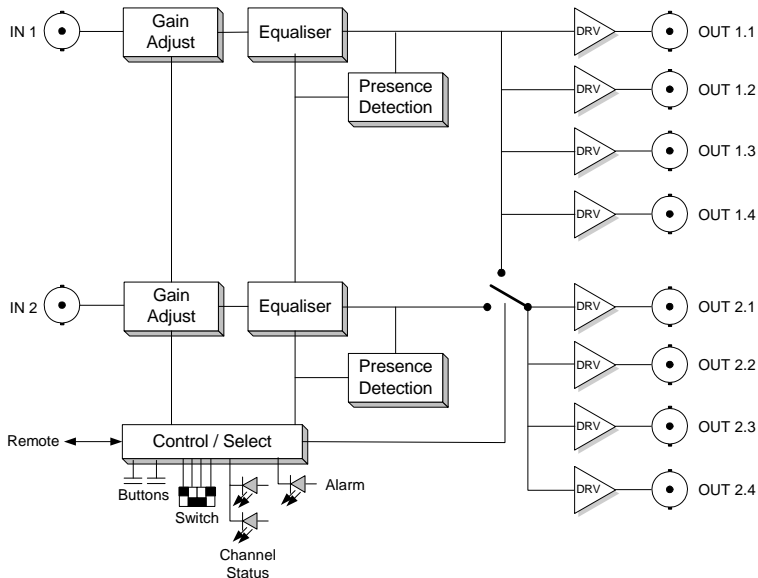

Figure 1- D VA 5720 Functional Diagram

Module Layout

Figure 2 shows the physical layout of the D VA 5720 CardModule. Video I/O is made on the supplied connection plate through standard BNC video connectors. Module configuration is set via a small dip-switch and a up-down push button located on the front of the PCB. When used in single mode (1x1:8) **IN 1** is used as the input signal.

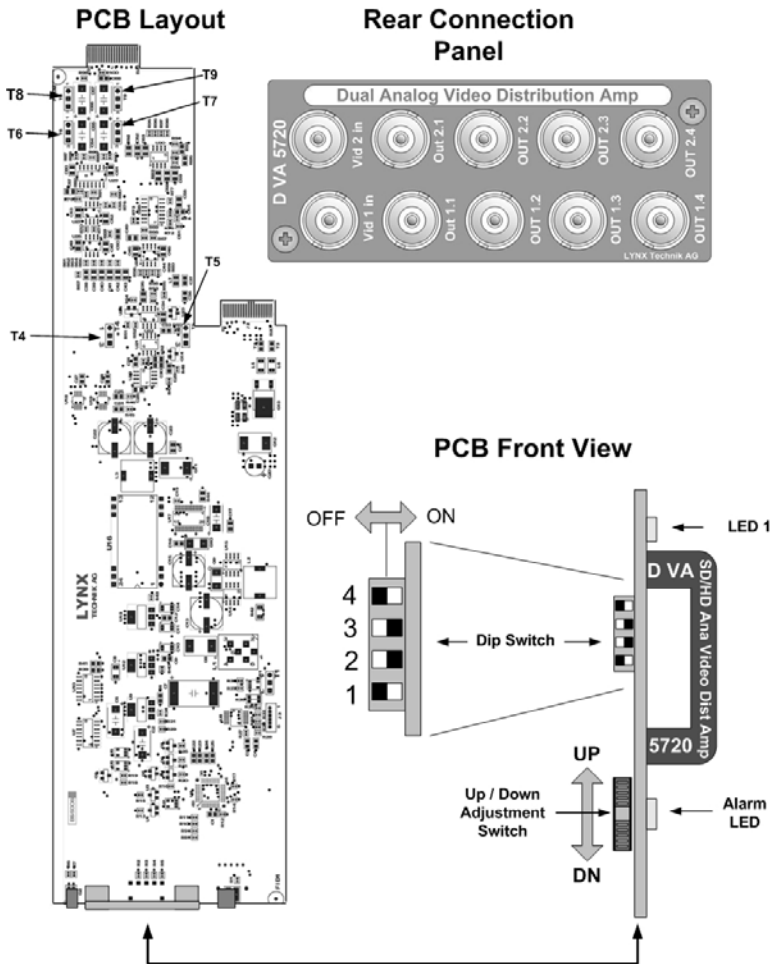

Figure 2 – Module Layout

Caution



Use static precautions when handling the PCB. Static discharge could result in serious damage to the module.

Connections

Video Connections

The D VA 5720 MiniModule is configured with standard 75 Ohm BNC connectors. Connection is self-explanatory. We recommend the use of high quality video cables to reduce the risk of interference or errors due to excessive cable attenuation.

Note. Due to the compact design of the rear connection plate it will be necessary to use a connection tool to secure the BNC video connectors to the module.

Installation



Caution

The CardModule is shipped in a protective anti-static bag. Please take suitable precautions to avoid static discharge onto any part of the PCB or components when handling module or serious damage could result.

Each Card Module is supplied with a rear connection panel and two mounting screws. Please follow the following procedure for installation of the card module into the Series 5000 Card Frame.

- a) Select a slot in the card frame where the CardModule will be located
- b) Remove the blank connection panel from the rear of the rack (if fitted)
- c) Install the rear connection panel using the screws supplied. Do not tighten the screws fully
- d) Slide the card module into the card frame and carefully check the CardModule easily connects to the rear connection plate. The card should fit easily and should not require excessive force to insert, if you feel high resistance, there could be something wrong with the rear connection panel location. Do not try and force the connection. Remove the rear connection panel and check alignment with the CardModule.
- e) Insert and remove the CardModule a few times to ensure correct alignment and then tighten the two screws to secure the rear connection plate

Settings and Control

The D VA 5720 is configured via 4-position dip-switch and a up-down push button located on the module card edge.

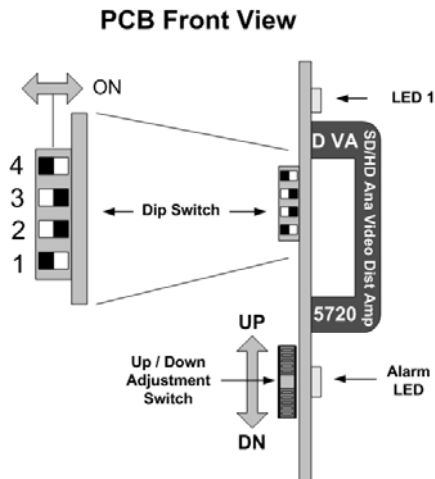

Switch Settings

Below the switch settings for the 4-position dip-switch are defined. Switch function is described in more detail after the table below.

Switch	Setting	Function
1	ON	Dual 1:4 mode
	OFF	Single 1:8 mode *
2	ON	Gain adjustment selected
	OFF	Equalizer adjustment selected
3	ON	Unity selected
	OFF	Unity not selected
4	ON	Channel 1 selected
	OFF	Channel 2 selected

*When in single mode the **IN 1** video input is used.

Switch Function Detail

The switches are used as part of an adjustment procedure and setting is not an implicit process. Please refer to the alignment procedure section for details on how to use the switches to set up the module. The information below simply describes function.

Dip Switch 1

This switch sets the configuration of the module. **ON** sets single 1:4 mode. **OFF** sets dual 1:8 mode.

Dip Switch 2

This switch selects the parameter for adjustment using the module push buttons. **ON** selects gain, **OFF** selects equalization.

Dip Switch 3

This switch sets unity gain / equalization for the module. **ON** selects unity, **OFF** allows for adjustment.

Dip Switch 4

This switch selects the channel for adjustment. **ON** selects channel 1, **OFF** selects channel 2.

Factory Preset Condition

The D VA 5720 is delivered preset for the following mode of operation:

Mode	2 x 1:4
Setting	Unity Gain, Unity Equalization
Input coupling	DC
Input clamp	ON

If this is the mode of operation required, then no adjustments are necessary.

Link Settings

Input coupling

It is possible to select AC or DC input coupling for each input channel. This is done using physical links on the card, and the card will need to be removed from the card frame for changes to be made*. Figure 3 shows the locations and settings

Input Clamp

The input clamping can be turned on or off for each input channel. This is done using physical links on the card and the card will need to be removed from the card frame for changes to be made*. Figure 3 shows the locations and settings.

Note. When set to single 1 > 8 mode of operation only channel 1 is used.

***Note.** It is not necessary to power down the frame to remove the card. All Series 5000 Card Modules can be hot plugged / unplugged.

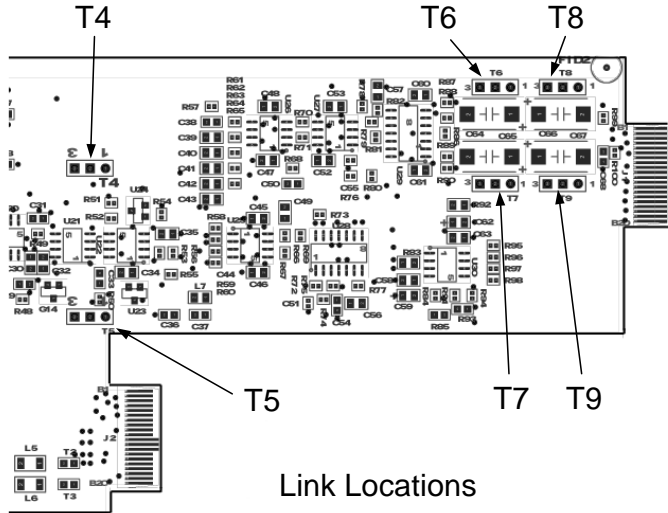













	T6	T7
Channel 1 DC Input Coupling	3  1	3  1
Channel 1 AC Input Coupling	3  1	3  1
	T8	T9
Channel 2 DC Input Coupling	3  1	3  1
Channel 2 AC Input Coupling	3  1	3  1
	T4	
Channel 1 Clamp ON	3  1	
Channel 1 Clamp OFF	3  1	
	T5	
Channel 2 Clamp ON	3  1	
Channel 2 Clamp OFF	3  1	

Figure 3. Link Locations and Settings

Adjustment Procedures

The modules configuration and gain/EQ settings are set using combinations of the Dip Switch and the up-down push button located on the module edge.

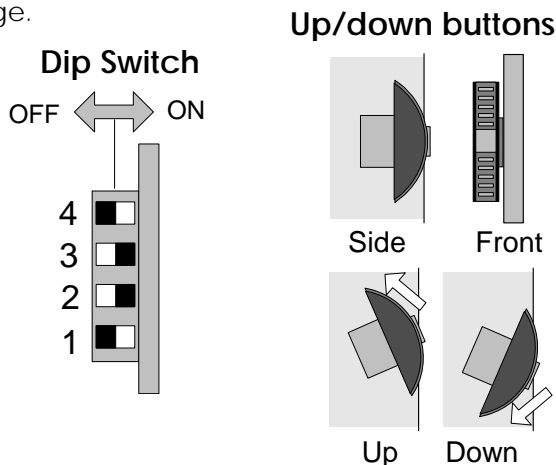

Setting functionality and calibration is interactive and not an implicit switch setting process. The adjustments are made through imbedded micro-controller and settings stored on internal flash ram. To simplify the configuration and setting of the module a series of procedures has been defined to make setting the module easier. These are:

- Set Dual 1:4 or 1:8 Mode
- Set Video Gain
- Set Equalization
- Set Unity Gain
- Set Unity Equalization

These procedures capture most things you would need to change or set on the module.

Set Dual 1:4 or 1:8 mode

The D VA 5720 module can be set to one of two preset modes of operation.

Dual 1:4 Mode. This is a simple 2 x 1 to 4 video amplifier. Independent left and right channels passed through the amplifier providing four outputs for each input channel.

Single 1:8 Mode. This is a simple 1 x 1 to 8 Video amplifier. The signal on the **IN 1** input channel is passed through the amplifier providing eight outputs.

Use this procedure to select 2 x 1 to 4 or 1 x 1 to 8 modes of operation.

1. Set Switch 1 to **OFF** for 1:8 mode* or **ON** for dual 1:4 mode
2. If 10 seconds pass with no further adjustment both channel status LEDs will flash yellow four times. This confirms setting has been written into flash ram and stored.

* When in 1: 8 mode the IN 2 channel indicator will go out.

Note. Diagram only shown for switch location reference not actual settings

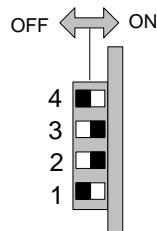

Set Video Gain

Use this procedure to set the video gain of the module.

1. Set Switch 1 to desired mode of operation **OFF** for 1:8 mode or **ON** for dual 1:4 mode
2. Set Switch 2 [*Gain / Equalization select*] to **ON**
3. Set Switch 3 [*Set Unity*] to **OFF**
4. Set switch 4 [*select input channel*] to select the channel to be adjusted **ON** for **IN 1** and **OFF** for **IN 2*** (respective LED will flash yellow once indicating selected channel)
5. Press the push button either **UP** or **DN** to make the necessary gain adjustment for the selected channel.
6. If using dual mode, set switch 4 to select the second channel and repeat 5 above.
7. If 10 seconds pass with no further adjustments being made both channel status LEDs will flash yellow four times. This confirms settings have been written into flash ram and stored.

* This switch is only used / functional when the module is configured for dual 1:4 mode of operation. If 1: 8 mode of operation is selected with switch 1, then the IN1 connection is used by default.

Note. Diagram only shown for switch location reference not actual settings

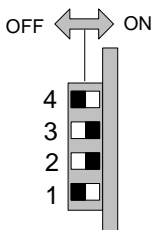

Set Equalization

Use this procedure to set the cable equalization for the module

1. Set Switch 1 to desired mode of operation **OFF** for 1:8 mode or **ON** for dual 1:4 mode
2. Set Switch 2 [*Gain / Equalization select*] to **OFF**
3. Set Switch 3 [*Set Unity*] to **OFF**
4. Set switch 4 [*select input channel*] to select the channel to be adjusted **ON** for **IN 1** and **OFF** for **IN 2*** (respective LED will flash yellow once indicating selected channel)
5. Press the push button either **UP** or **DN** to make the necessary equalization adjustment for the selected channel.
6. If using dual mode, set switch 4 to select the second channel and repeat 5 above.
7. If 10 seconds pass with no further adjustments being made both channel status LEDs will flash yellow four times. This confirms settings have been written into flash ram and stored.

* This switch is only used / functional when the module is configured for dual 1:4 mode of operation. If 1: 8 mode of operation is selected with switch 1, then the IN1 connection is used by default.

Note. Diagram only shown for switch location reference not actual settings

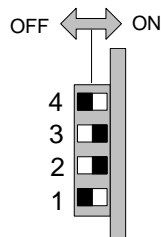

Set Unity Gain

Use the following procedure to set unity gain for the module

1. Set Switch 1 to desired mode of operation **OFF** for 1:8 mode or **ON** for dual 1:4 mode
2. Set Switch 2 [*Gain / Equalization select*] to **ON**
3. Set Switch 3 [*Set Unity*] to **ON**
4. Set switch 4 [*Select input channel*] to select the channel to be adjusted to unity **ON** for **IN 1** and **OFF** for **IN 2*** (respective LED will flash yellow once indicating selected channel)
5. Press the push button either **UP** or **DN** once to set unity gain for the selected channel.
6. If using dual mode, set switch 4 to select the second channel and repeat 5 above.
7. If 10 seconds pass with no further adjustments being made both channel status LEDs will flash yellow four times. This confirms settings have been written into flash ram and stored.

* This switch is only used / functional when the module is configured for dual 1:4 mode of operation. If 1: 8 mode of operation is selected with switch 1, then the IN1 connection is used by default.

Note. Diagram only shown for switch location reference not actual settings

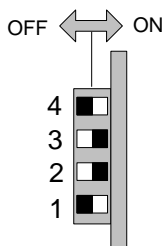

Set Unity Equalization

Use the following procedure to set unity equalization.

1. Set Switch 1 to desired mode of operation **OFF** for 1:8 mode or **ON** for dual 1:4 mode
2. Set Switch 2 [*Gain / Equalization select*] to **OFF**
3. Set Switch 3 [*Set Unity*] to **ON**
4. Set switch 4 [*Select input channel*] to select the channel to be adjusted to unity **ON** for **IN 1** and **OFF** for **IN 2*** (respective LED will flash yellow once indicating selected channel)
5. Press the push button either **UP** or **DN** once to set unity equalization for the selected channel.
6. If using dual mode, set switch 4 to select the second channel and repeat 5 above.
7. If 10 seconds pass with no further adjustments being made both channel status LEDs will flash yellow four times. This confirms settings have been written into flash ram and stored.

* This switch is only used / functional when the module is configured for dual 1:4 mode of operation. If 1: 8 mode of operation is selected with switch 1, then the IN1 connection is used by default.

Note. Diagram only shown for switch location reference not actual settings

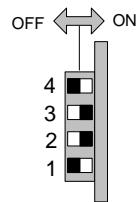

Auto Store

If no parameters are changed for 10 seconds then the current settings will be written into flash memory automatically, this can be seen by the channel condition LEDs flashing yellow four times.

Alarm/LED Status Indicators

The D VA 5720 module has integral LED indicators, which serve as alarm and status indication for the module. Function is described below.

The Indicators are clearly visible on the front edge of the module PCB (Figure 2)

Channel Condition Indicators

Two status LED`s are provided, one for each channel (figure 2) Function described below.

LED Color	Indication
Green	Input Present
Yellow	Adjustment aid
Red	No input

Front Panel Alarm Indicator

There is also a single alarm LED that is designed for quick and easy indication of a problem condition. This is visible through the front cover of the rack frame when fitted.

LED Color	Indication
Green	Signal Present (in 2 x 1:4 mode green = both signals present)
Yellow	One input signal missing (in 2 x 1:4 only, LED not active in 1:8 mode)
Red	No input signal on active inputs

LED **OFF** indicates power is lost, or there is a power supply fault.

Locate Function

For larger systems which may have multiple cards of the same type in a single rack, or multiple rack systems on a large central control system we have added a useful utility which will help to visually locate a suspect module quickly (When used in conjunction with the optional control system and software)

Once the specific module has been selected on the control system there is a locate button on the top of the GUI:

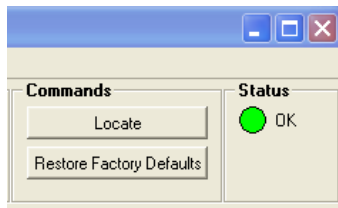

Locate Function in Control System

When Locate is selected the status indicator on the GUI and the module LEDs will flash yellow in the following continuous sequence.

3 short flashes.... Pause.... 3 short flashes ...

This uses the alarm LED located on the front of the module and in some cases any channel or status LEDs that may be used in the module.

Use of the locate function will not interfere with the normal operation of the module.

For more details on this feature please check the documentation supplied with the controller software.

Specifications *(D VA 5720)*

Inputs

Signal	2 x analog video, differential input 75 Ohm Sync Signal can be SDTV bi-Level (black burst) or HDTV Tri-Level
Input Impedance	75 Ohm
Input level (max)	2V p-p
Return loss	> 31dB to 10MHz
Common Mode Rejection	> 65dB to 10 KHz
Connection	BNC, 75 Ohm

Outputs

Signal	8 x analog video return loss 46,5 dB to 10 MHz
Phase match	< 0.1° at 4.43 MHz
Response Variation	< 0.15dB to 8 loads
Connection	BNC, 75 Ohm
Adjustment range	-3 dB / +3 dB in 256 increments

Operating Modes

Dual	Dual Distribution Amplifier 1:4
Single	Single Distribution Amplifier 1:8

Performance

Frequency Response	+/- 0.1dB to 30 MHz, -3dB at 66 MHz
Differential Gain	<0.20%
Differential Phase	<0.15°
Hor./Vert. tilt	< 0.5%
Signal to noise ratio	>69 dB to 17MHz (RMS noise/700mV, unweighted)
Hum	< 0.5 mV
Gain	-3 dB / +3 dB in 256 increments
Cable Equalization	Up to 200m using Belden 8281
Control	Local settings (dip switch).
Status Monitoring (LED)	Signal presence and alarm

Electrical Specifications

Operating Voltage	+ 5VDC
Power Consumption	4 VA
Connection	DC input via 5 pin locking bayonet connector
Safety	IEC 60950/ EN 60950/VDE 0805

Mechanical

Size	283mm x 78mm
Weight	Card module 120g, connection panel 70g

Ambient

Temperature	5°C to 40°C Maintaining specifications -20°C to +70°C Storage
Humidity	Max 90% non condensing

Supplied Accessories

Documentation	Reference Manual CD
---------------	---------------------

Available Options

Below is a list of available options for the D VA 5720 CardModule. Please refer to product brochures or our web site for more detailed information.

Model	Description
R FR 5010	Series 5000 Rack Frame (empty) with single power supply
R FR 5011	Series 5000 Rack Frame (empty) with single power supply including a fan front cover
R PS 5010	Redundant power supply for the R FR 5010 Card Frame
R CT 5020	Rack controller for the R FR 5010 Card Frame
R CT 5030	Master controller with TCP/IP interface for the R FR 5010 Card Frame
R CT 5010	Rack Bus Extension for the R FR 5010 Card Frame. In combination with R CT 5020

Parts List

Due to the very dense design and miniature surface mount technology the module is not field serviceable. The information for a replacement assembly is below.

D VA 5120 (complete)

Description	Dual Analog Video D Amp
Model Number	D VA 5720
Part Number	6.155.005.620

Sub Assemblies:

Processing Board Only (BS 5706 A)

Part Number	6.155.005.706
-------------	---------------

Rear Connection Plate for D VA 5120 (MA 5001A)

Part Number	6.155.001.124
-------------	---------------

Service

If you are experiencing problems, or have questions concerning your D VA 5720 CardModule please contact your local distributor for assistance.

We offer a fixed cost service exchange program for defective Series 5000 CardModules out of Warranty. Please contact your distributor or check our web site for details on this program.

More detailed information and product updates may be available on our web site:

www.lynx-technik.com

You will also find links to contact us directly for assistance.

Contact Information

Please contact your local distributor; this is your local and fastest method for obtaining support and sales information.

LYNX Technik can be contacted directly using the information below.

Address LYNX Technik AG
Brunnenweg 3
D-64331 Weiterstadt
Germany.

Website www.lynx-technik.com

E-Mail info@lynx-technik.com

LYNX Technik manufactures a complete range of high quality modular products for broadcast and Professional markets, please contact your local representative or visit our web site for more product information.

