

Reference Manual

D VO 5820

**3GBit/s Dual SDI/ASI Distribution Amplifier
with optical I/O**

**Revision 1.0
June 2010**

This Manual Supports Device Revisions:	
D VO 5820 Firmware Revision	384
Control System GUI Release	4.7.5



Information in this document is subject to change without notice. No part of this document may be reproduced or transmitted in any form or by any means, electronic or mechanical for any purpose, without express written permission of LYNX Technik AG.

LYNX Technik AG may have patents, patent applications, trademarks, copyrights or other intellectual property rights covering the subject matter in this document. Except as expressly written by LYNX Technik AG, the furnishing of this document does not give you any license to patents, trademarks, copyrights or other intellectual property of LYNX Technik AG or any of its affiliates.

**LYNX Technik AG
Brunnenweg 3
D 64331 Weiterstadt
Germany
www.lynx-technik.com**

Contents

CONTENTS	2
WARRANTY	3
REGULATORY INFORMATION	4
EUROPE	4
USA	4
GETTING STARTED	5
PACKAGING	5
ESD WARNING	5
<i>Preventing ESD Damage</i>	5
PRODUCT DESCRIPTION	6
FUNCTIONAL DIAGRAM	6
MODULE LAYOUT	7
CONNECTIONS	8
INSTALLATION	8
SETTINGS AND CONTROL	9
SWITCH SETTINGS	10
<i>Switch Function Detail</i>	10
<i>Factory Preset Condition</i>	10
<i>Auto Store</i>	10
ALARM/LED STATUS INDICATORS	11
<i>Channel Condition Indicators</i>	11
<i>Alarm Indicator</i>	11
CONTROL SYSTEM GUI	12
<i>Main Tab</i>	13
<i>Events Tab</i>	14
SPECIFICATIONS	15
SERVICE	17
<i>Parts List</i>	17
<i>Technical Support</i>	17
<i>Contact Information</i>	17

Warranty

LYNX Technik AG warrants that the product will be free from defects in materials and workmanship for a period of two (2) year from the date of shipment. If this product proves defective during the warranty period, LYNX Technik AG at its option will either repair the defective product without charge for parts and labor, or will provide a replacement in exchange for the defective product.

In order to obtain service under this warranty, customer must notify LYNX Technik of the defect before expiration of the warranty period and make suitable arrangements for the performance of service. Customer shall be responsible for packaging and shipping the defective product to the service center designated by LYNX Technik, with shipping charges prepaid. LYNX Technik shall pay for the return of the product to the customer if the shipment is within the country which the LYNX Technik service center is located. Customer shall be responsible for payment of all shipping charges, duties, taxes and any other charges for products returned to any other locations.

This warranty shall not apply to any defect, failure, or damage caused by improper use or improper or inadequate maintenance and care. LYNX Technik shall not be obligated to furnish service under this warranty a) to repair damage resulting from attempts by personnel other than LYNX Technik representatives to install, repair or service the product; b) to repair damage resulting from improper use or connection to incompatible equipment; c) to repair any damage or malfunction caused by the use of non LYNX Technik supplies; or d) to service a product which has been modified or integrated with other products when the effect of such modification or integration increases the time or difficulty servicing the product.

THIS WARRANTY IS GIVEN BY LYNX TECHNIK WITH RESPECT TO THIS PRODUCT IN LIEU OF ANY OTHER WARRANTIES, EXPRESS OR IMPLIED. LYNX TECHNIK AND ITS VENDORS DISCLAIM ANY IMPLIED WARRANTIES OF MERCHANTABILITY OR FITNESS FOR A PARTICULAR PURPOSE. LYNX TECHNIK'S RESPONSIBILITY TO REPAIR AND REPLACE DEFECTIVE PRODUCTS IS THE SOLE AND EXCLUSIVE REMEDY PROVIDED TO THE CUSTOMER FOR BREACH OF THIS WARRANTY. LYNX TECHNIK AND ITS VENDORS WILL NOT BE LIABLE FOR ANY INDIRECT, SPECIAL, INCIDENTAL, OR CONSEQUENTIAL DAMAGES IRRESPECTIVE OF WHETHER LYNX TECHNIK OR THE VENDOR HAS ADVANCE NOTICE OF THE POSSIBILITY OF SUCH DAMAGES.

Regulatory information

Europe

Declaration of Conformity

<i>We</i>	LYNX Technik AG Brunnenweg 3 D-64331 Weiterstadt Germany
	<i>Declare under our sole responsibility that the product</i>
	TYPE: D VO 5820
	<i>To which this declaration relates is in conformity with the following standards (environments E1-E3):</i>
	EN 55103-1 /1996
	EN 55103-2 /1996
	EN 60950 /2001
	<i>Following the provisions of 89/336/EEC and 73/23/EEC directives.</i>
	Winfried Deckelmann
Weiterstadt, June 2010	
<i>Place and date of issue</i>	<i>Legal Signature</i>

USA

FCC 47 Part 15

This device complies with part 15 of the FCC Rules. Operation is subject to the following two conditions: (1) This device may not cause harmful interference, and (2) this device must accept any interference received, including interference that may cause undesired operation.

Note: This equipment has been tested and found to comply with the limits for a Class A digital device, pursuant to the part 15 of the FCC Rules. These limits are designed to provide reasonable protection against harmful interference when the equipment is operated in a commercial environment. This equipment generates, uses, and can radiate radio frequency energy and, if not installed and used in accordance with the instruction manual, may cause harmful interference to radio communications. Operation of this equipment in a residential area is likely to cause harmful interference in which case the user will be required to correct the interference at his own expense

Getting Started

Most CardModules are installed into the rack frames and system tested in the factory. If this is an upgrade part, or service exchange item then the module is supplied in a padded cardboard carton which includes the CardModule, rear connection plate and mounting screws.

Packaging

The shipping carton and packaging materials provide protection for the module during transit. Please retain the shipping cartons in case subsequent shipping of the product becomes necessary. Do not remove the module from its protective static bag unless observing adequate ESD precautions. Please see below.

ESD Warning



This product is static sensitive. Please use caution and use preventative measures to prevent static discharge or damage could result to module.

Preventing ESD Damage

Electrostatic discharge (ESD) damage occurs when electronic assemblies or the components are improperly handled and can result in complete or intermittent failure.

Do not handle the module unless using an ESD-preventative wrist strap and ensure that it makes good skin contact. Connect the strap to any solid grounding source such as any exposed metal on the rack chassis or any other unpainted metal surface.

Caution

Periodically check the resistance value of the antistatic strap. The measurement should be between 1 and 10 Megohms.

Product Description

The D VO 5820 is a high quality 3GBit/s / HD / SD SDI/ASI distribution amplifier with optical I/O designed primarily for broadcast and professional applications.

The D VO 5820 is a dual 1 to 4 distribution amplifier, providing one electrical BNC and two optical inputs and 3 electrical BNC outputs and one optical output per channel. Inputs can be relocked, or non-relocked. Auto detection of multirate digital video bit rates in relocked mode (143Mbit/s, 177Mbit/s, 270Mbit/s, 1.485 GBit/s, 2.985Gbit/s) and will transparently pass data from 15 Mbits/s to 2.985 Gbit Mbits/s in non-relocked mode.

Note: To ensure high signal quality the SDI receivers are located on the connection plate.

The D VO 5820 is part of the 5000 series of CardModules, which offer high quality, modularity and flexibility in a small form factor ideal for applications where space is at a premium.

Functional Diagram

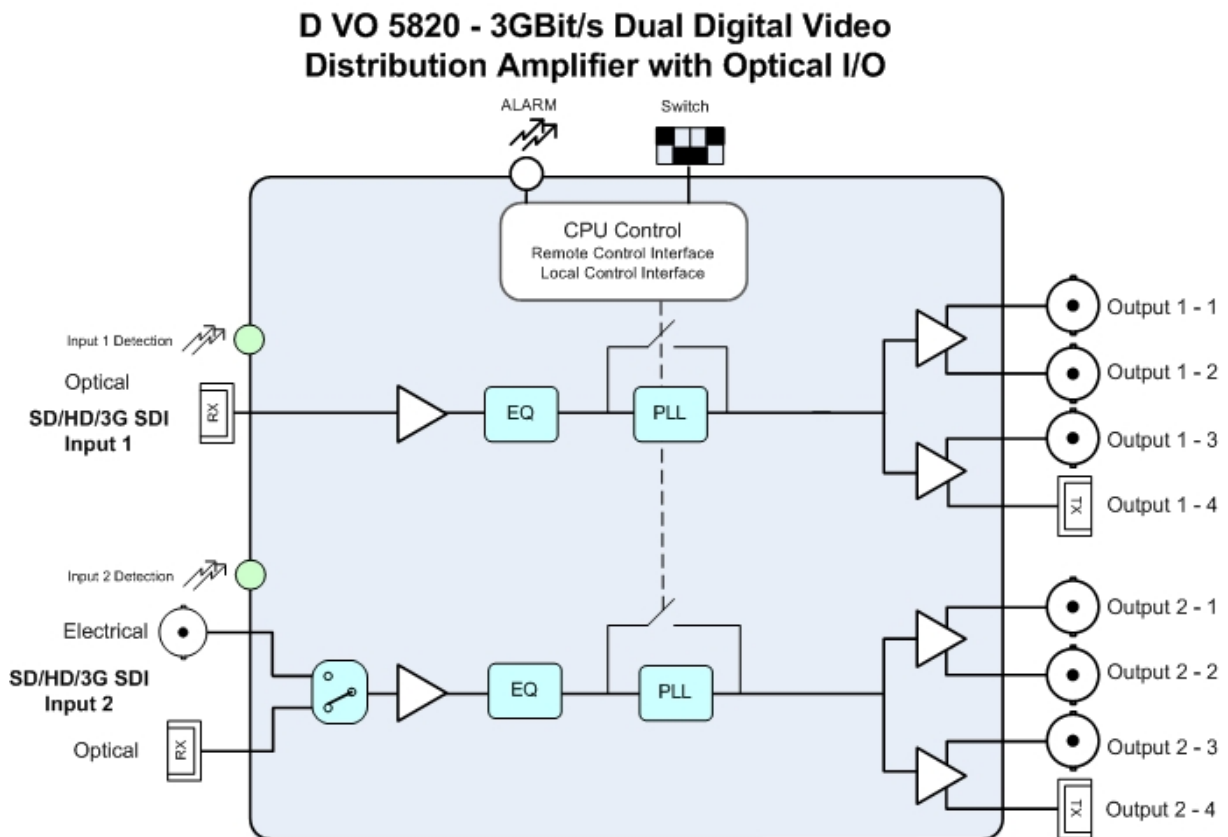

Module Layout

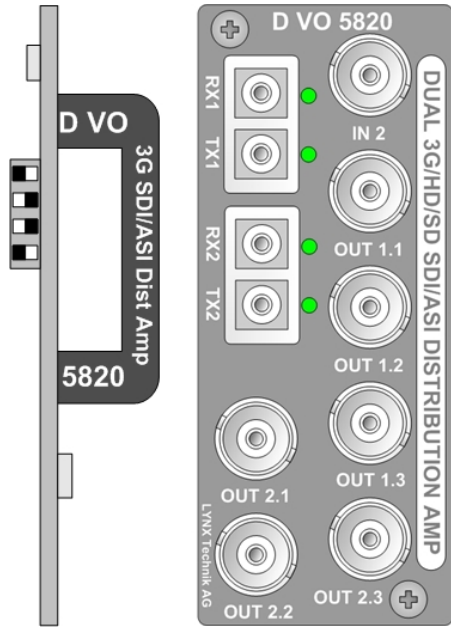

Module Front Termination Panel

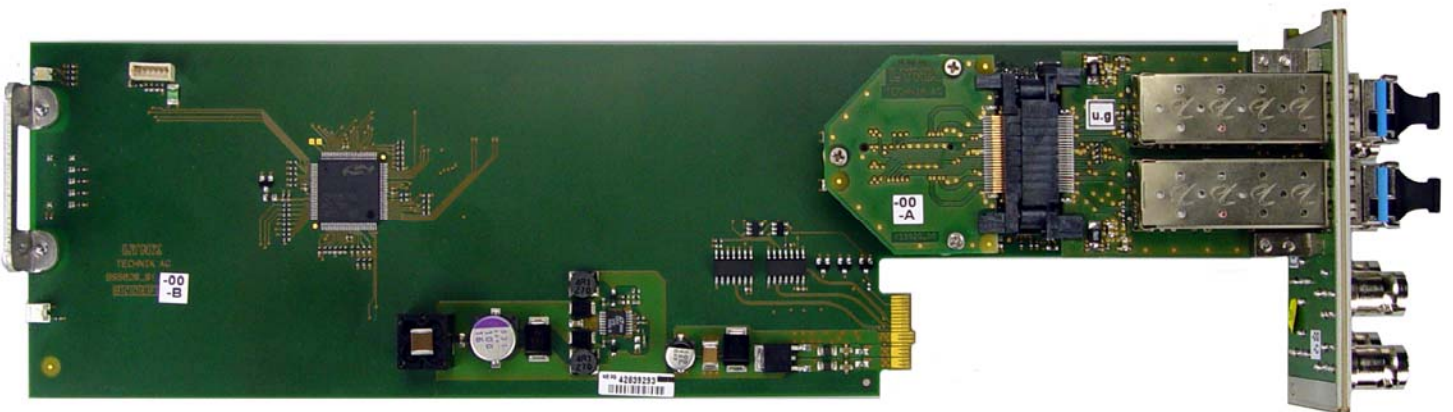

CardModule

Connections

BNC Video

The D VO 5820 uses standard 75 Ohm BNC connectors. We recommend the use of high quality video cable for digital video connections to reduce the risk of errors due to excessive cable attenuation. Max cable lengths the module will support are shown below.

SDTV = 250m Belden 8281 (270Mbits/s)
HDTV = 140m Belden 1694A (1.485Gbits/s)
3Gbit/s = 80m Belden 1694A (2.97Gbits/s)

Note. *Due to the compact design of the connection plate it will be necessary to use a connection tool to secure the BNC video connectors.*

Optical Fiber

The D VO 5820 provides LC/PC connectors for single mode fiber cables.

Multimode fiber cables can be used also, but this will limit the max. fiber length to approx. 1km.



NOTE: *Please take care that surfaces of fiber cables and LC connectors are always protected against scratching and dust if not fiber cables are connected. Dust and/or scratches will lead to high attenuation of the optical power transmitted.*

Installation

If this module was supplied as part of a system it is already installed in the rack enclosure. If the module was supplied as a field upgrade please follow the installation procedure below.



NOTE *Observe static precautions when handling card. Please see ESD warnings on Page 5.*

Each Card Module is supplied with a rear connection panel and two mounting screws. Please follow the following procedure for installation of the card module into the Series 5000 Card Frame.

1. Select a slot in the card frame where the CardModule will be located.
2. Remove the blank connection panel from the rear of the rack (if fitted)
3. Install the rear connection panel using the screws supplied. Do not tighten the screws fully
4. Slide the card module into the card frame and carefully check the CardModule connects to the rear connection plate. The card should fit easily and should not require excessive force to insert, if you feel any resistance, there could be something wrong with the rear connection panel location. Do not try and force the connection this may damage the connectors. Remove the rear connection panel and check alignment with the CardModule.

5. Insert and remove the CardModule a few times to ensure correct alignment and then tighten the two screws to secure the rear connection plate.

Settings and Control

The D VO 5820 has an integrated micro-controller, which enables the module to be configured and controlled locally via the dip-switch or from remote when using one of the optional controllers and control software.

Once set, all settings are automatically saved in non-volatile internal memory. (Flash ram) The module will always recall the settings used prior to power down.

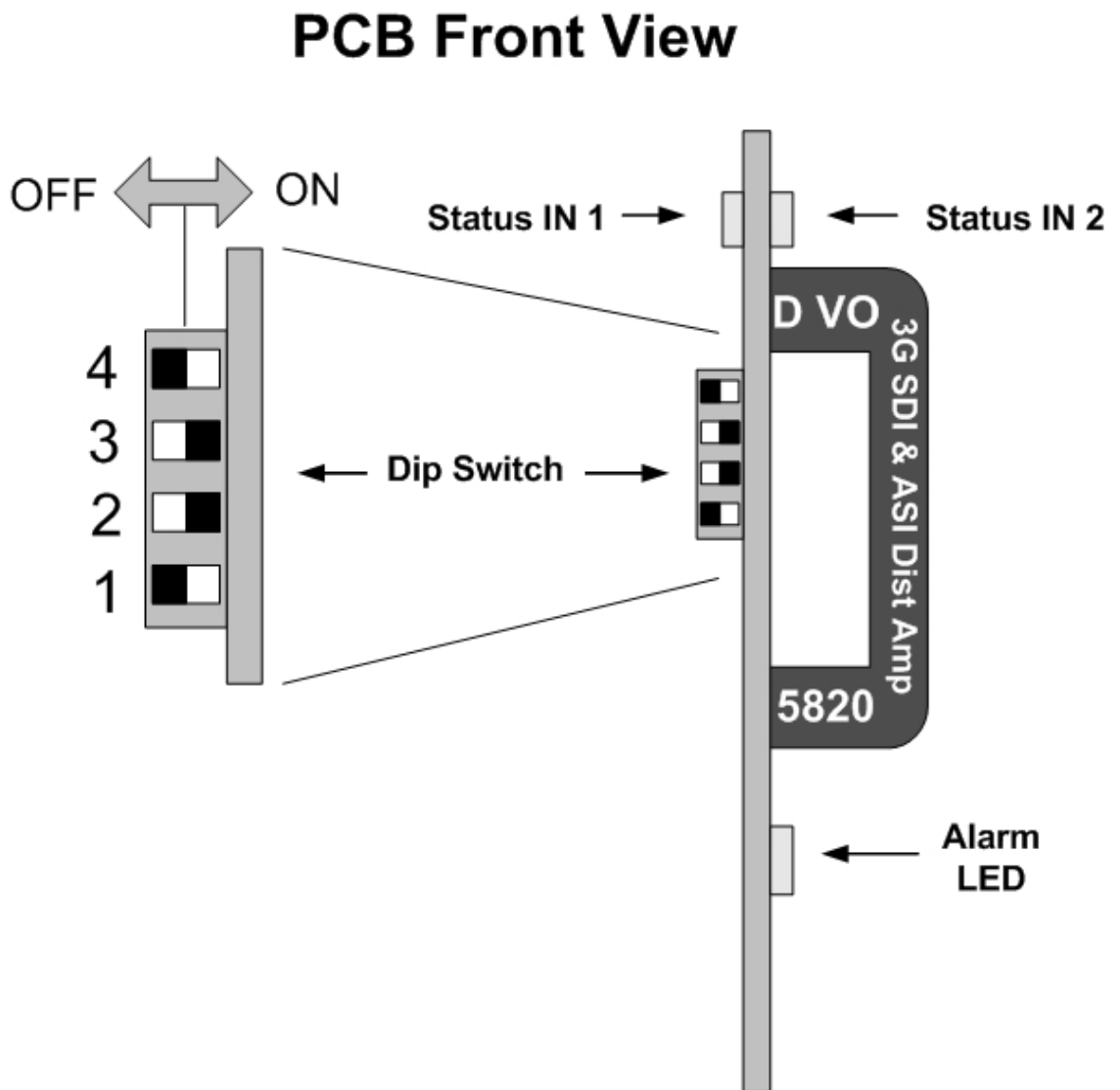

Figure 3 – Switch and LED locations

Switch Settings

Below the switch settings for the 4-position dip-switch are defined.

Switch	Setting	Function
1	ON	Enable Local Adjustment
	OFF	Disable Local Adjustment
2	ON	All outputs relocked
	OFF	All outputs non-relocked
3	ON	Input 2: electrical input
	OFF	Input 2: optical input
4	ON	Not used
	OFF	Not used

Switch Function Detail

Dip Switch 1

This switch is used to enable or disable local adjustments. Set to **ON** enables the setting of the other dip switches to configure the module. Set to **OFF** will prevent any switch settings taking effect.

Note. The module has a microcontroller and flash ram. When this switch 1 is set to **ON** any configuration settings made on the module with the dip switches will automatically be written into flash ram and stored. (see Auto Store) The module will function normally with the switch left in the **ON** position but it is recommended to set it to **OFF** to prevent accidental changes to the stored module configuration if the switches are moved.

Dip Switch 2

This switch configures outputs 1 to 8 to be relocked or non relocked. **ON** sets relocked, **OFF** sets non-relocked

Dip Switch 3

This switch configures input 2: **ON** sets Input 2 to electrical input **OFF** sets Input 2 to optical input

Dip Switch 4

Not used

Factory Preset Condition

The D VO 5820 is delivered programmed and preset for the following mode of operation:

Switch 1 **ON** Local Adjustment Enabled
 Switch 2 **ON** All outputs relocked
 Switch 3 **OFF** Input 2 optical
 Switch 4 **OFF** n.a.

If this is the mode of operation required, then no adjustments are necessary.

Auto Store

If no parameters are changed for 10 seconds then the current settings will be written into flash memory automatically, this can be seen by the channel status LEDs flashing yellow four times.

Alarm/LED Status Indicators

The D VO 5820 module has integral LED indicators, which serve as alarm and status indication for the module. Function is described below.

Channel Condition Indicators

2 status LEDs are provided on the top edge of the module, one for each channel (figure 3)

LED Color	Indication
Green	Input Present
Red	Input missing

Alarm Indicator

There is also a single alarm LED on the lower edge of the module (figure 3). This is visible through the card frame front cover and provides a general indication of the module status.

LED Color	Indication
Green	Both Signals Present (locked)
Yellow	One signal present, one signal missing
Red	Both Input signals missing

LED **OFF** indicates power is lost, or there is a power supply fault.

Control System GUI

When using the module in a system with the optional LYNX control system all module settings are available on an intuitive Windows GUI interface.

Any settings made using the control system will override any settings made locally. All settings are stored automatically in the module flash RAM.

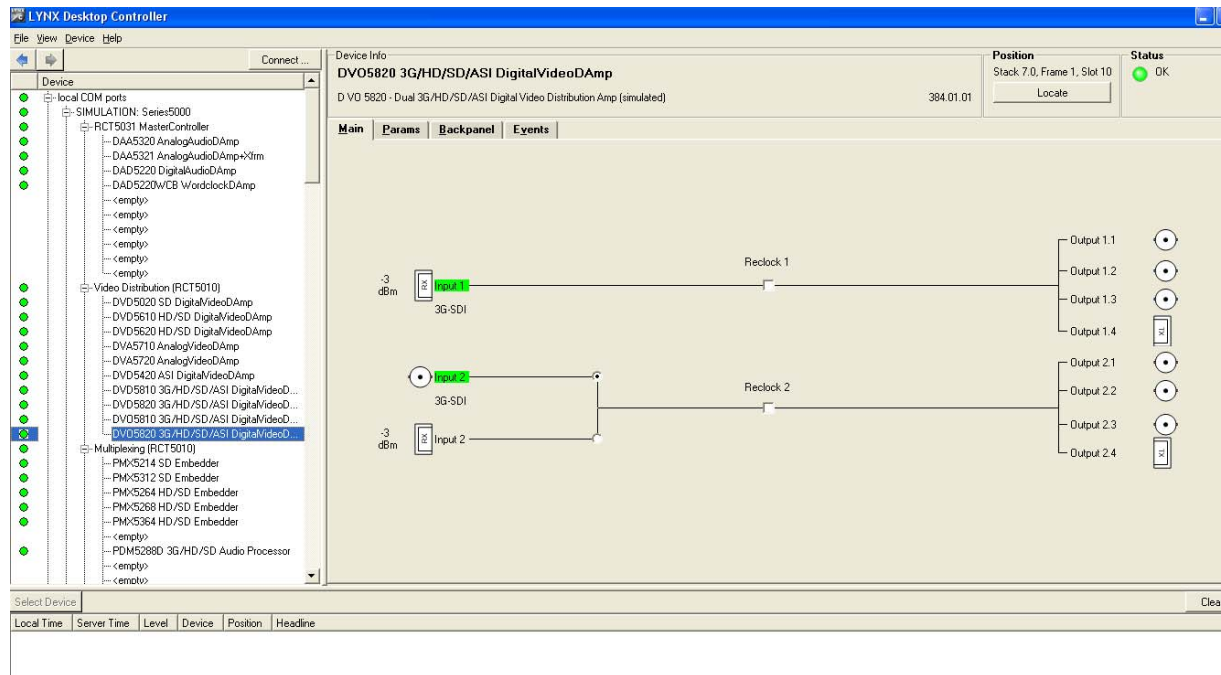

The above screenshot shows the complete module GUI. The Device info area contains information about the module including name and firmware revision. If used as part of a larger system (using the LYNX central control system) the modules position and physical location is displayed above the “locate” button.

Note. The Locate function is a tool used to quickly identify a module in larger systems. Selecting “locate” will flash the module alarm LED yellow. (This does not effect module operation)

The first screen displayed when the module is selected is the **Main Tab** this is a graphical representation of the modules overall function and signal flow (left to right).

The area at the bottom of the screen is the error log. Any fault condition (or event) will be time stamped and entered into the log.

There are a number of “Tabs” along the top of the screen which splits up the module settings into a number of logical displays. The various GUI screens and primary functions are described below.

Main Tab

This screen is the main interface and is presented first when the module is displayed in the GUI.

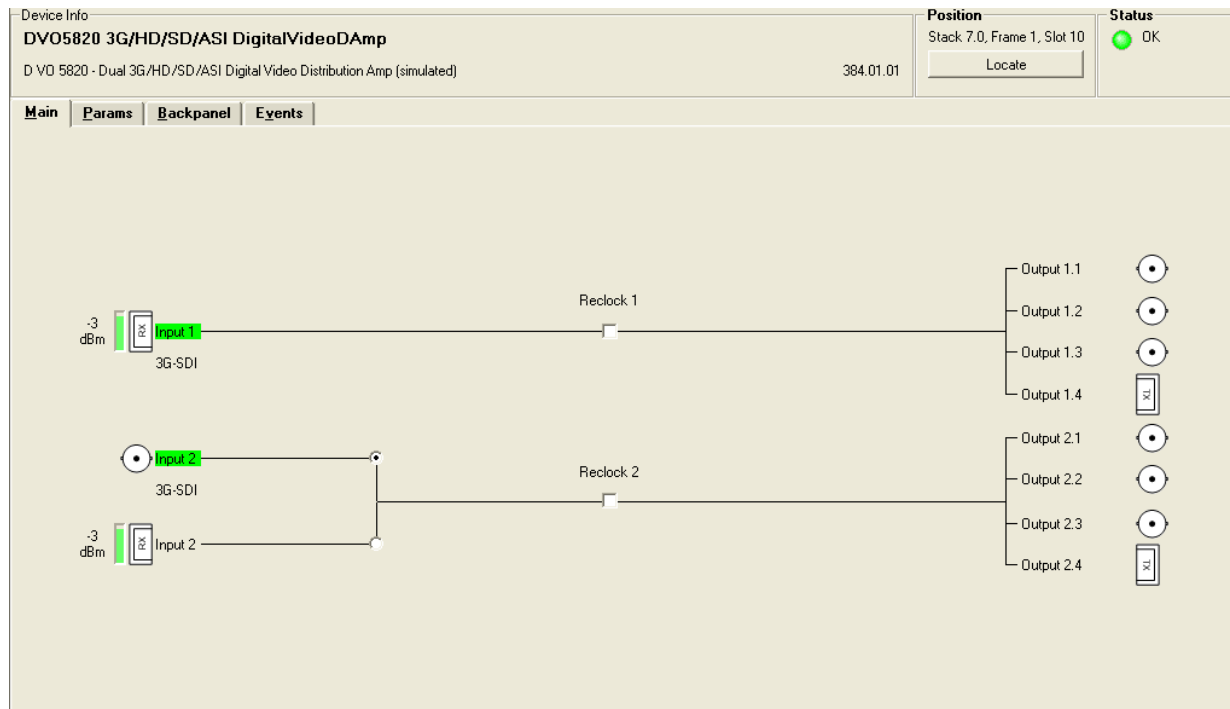

The input detection indicates the bit rate (SD-SDI = 270MBit/s, HD-SDI = 1.5 GBit/S; 3G-SDI = 3GBit/s) of a connected signal. If no signal is detected the color of the input detection will turn red.

For input 2 radio buttons for selection of the electrical/optical input is provided.

The receiving power of the optical inputs is indicated in dBm

The two check boxes enable or disable the input reclocking of the respective input.

Events Tab

The Events Tab is where the module alarming and error notifications are configured for the module.

Device Info

DVO5820 3G/HD/SD/ASI DigitalVideoDAmp

D VO 5820 - Dual 3G/HD/SD/ASI Digital Video Distribution Amp (simulated)

Main | **Params** | **Backpanel** | **Events**

Activate or deactivate event notifications by clicking the "event enable" boxes.

Enable and disable entry into the logfile for status changes of any event to active ("ON") or to inactive ("OFF") by selecting the respective "log in GUI" boxes.

simulate event	event enabled		log in GUI <small>(on/off)</small>	SNMP Trap <small>(on/off)</small>
<input type="checkbox"/>	<input checked="" type="checkbox"/>	SDI Input 1: No Input	<input checked="" type="checkbox"/> <input checked="" type="checkbox"/>	<input type="checkbox"/> <input type="checkbox"/>
<input type="checkbox"/>	<input checked="" type="checkbox"/>	SDI Input 2: No Input	<input checked="" type="checkbox"/> <input checked="" type="checkbox"/>	<input type="checkbox"/> <input type="checkbox"/>

The GUI has an integrated error log, which is a simple text log file stored in the controller PC. This will record an event and timestamp it. The log can be seen at the bottom of the GUI screen and can be scrolled through using the scrolling bar.

Log in GUI Function

Events are selectable, you can chose if you want to record a particular event in the log (or not) or configure it to only record one side of the event. *(For example you might want to log when a SDI input was removed but do not want to log when it came back).* The ON/OFF trigger can be configured for each of the available events shown in the list and is setup using the checkboxes provided.

Event Enabled

By default all alarm conditions are activated (checked), by de-selecting a specific alarm condition in this column you are telling the module to ignore this condition completely. It will not color the Alarm LED, log and event in the GUI or send a SNMP trap. This is useful if for example you never have anything connected to input 2 and want the card to ignore this input condition completely you would simply de-select "SDI Input 2 No Input" and it will be ignored.

SNMP Support

If the system is using a RCT 5031 Master Controller and the SNMP option is installed then the "SNMP Trap" columns become available.

Here you can configure what events you would like to transmit a "SNMP trap" for over the network. (This has no impact or influence over the internally error log maintained by the LYNX control system)

(Internal LYNX error logging and external SNMP traps can be configured independently).

Note. *The simulated event is part of the GUI simulator and allows us to force a particular error condition for testing and demonstration purposes.*

Specifications

Video Inputs (BNC)	
Signal Type	Serial digital video SMPTE 292M, 259M-C, 424M, DVB-ASI and SMPTE 310
No. of inputs	1 (channel 2))
Connector	BNC
Impedance	75 Ohm
Cable Equalization	Up to 250m Belden 8281 (270MBit/s) Up to 140m Belden 1694A (1.485GBit/S) Up to 80m Belden 1694A (2.97GBit/s)
Return Loss	> 15 dB (270MBit/s) > 10dB (1.485GBit/s)
Video Inputs (Fiber)	
Signal Type	SMPTE 297M-2006
No. of inputs	2 (one for each channel)
Connector	LC/PC (single mode transmit/receive – duplex connection)
Wavelength	1260nm – 1620nm (-19dBm sensitivity)
Digital Video Outputs (BNC)	
Signal Type	Serial digital video SMPTE 259M-C, 292M, 424M, DVB-ASI and SMPTE 310
No. of outputs	6 (2 outputs in pairs of 3)
Connector	BNC
Impedance	75 Ohms
Jitter	< 0.2 UI (270MHz) < 0.2 UI (Alignment Jitter); < 1.0 UI (Timing Jitter); (1.485GHz) < 0.3 UI (Alignment Jitter); < 2.0 UI (Timing Jitter); (2.97GHz)
Return Loss	> 15 dB (1.5GBit/s)
Digital Video Outputs (Fiber)	
Signal Type	SMPTE 297M-2006
No. of outputs	2 (one for each channel)
Connector	LC/PC (single mode transmit/receive – duplex connection)
Wavelength	Standard: 1310nm (non-CWDM), other wavelength for CWDM as option
Transmission power	Standard: 1310nm (non-CWDM):-5dBm, other wavelength for CWDM as option: -1dBm
Control	
Local Controls	Dip Switch
Remote Control	Comprehensive remote control and status monitoring supported when used with a LYNX Controller option

Electrical Specifications	
Voltage	12 VDC
Power	<6W
Safety	IEC 60950/ EN 60950/ VDE 0805
Mechanical	
Size	283mm x 78mm
Weight	CardModule 150g, connector plate 70g
Ambient	
Temperature	5°C to 40°C Maintaining specifications
Humidity	90% Max non condensing

Service

Parts List

Due to the very dense design and high level of integration there the module is not user serviceable. Please contact LYNX for repairs or to request an exchange unit.

Technical Support

If you are experiencing problems, or have questions please contact your local distributor for further assistance.

Technical support is also available from our website.

Please do not return products to LYNX without an RMA. Please contact your authorized dealer or reseller for more details.

More detailed product information and product updates may be available on our web site:

www.lynx-technik.com

Contact Information

Please contact your local distributor; this is your local and fastest method for obtaining support and sales information.

LYNX Technik can be contacted directly using the information below.

Address LYNX Technik AG
Brunnenweg 3
D-64331 Weiterstadt
Germany

Website www.lynx-technik.com

E-Mail info@lynx-technik.com

LYNX Technik manufactures a complete range of high quality modular products for broadcast and Professional markets, please contact your local representative or visit our web site for more product information.

